

U series
经典系列音箱
CLASSIC SPEAKER



pro audio



U series is a group of classic professional speaker with the characteristics of high power, high SPL, clear and bright full-range sound, rich and elastic bass, all use high quality units. The cabinet is made of multi-layer composite plywood with wear-resistant polyurea paint.

U系列是一组经典专业音箱，具有功率大、输出声压级高、全频声音清新明亮、超低丰满且有弹性等特点。全部采用高品质单元配置，箱体采用多层复合夹板，耐磨聚脲喷涂。

FEATURES

- High quality units, high strength plywood
- Multi-hanging points and support, easy and quick operation
- Complete models
- **Applications:** conference rooms, multi-purpose halls, various entertainment venues, mobile performances

产品特点

- 高质量单元配置，高强度夹板
- 多吊挂点与支撑配合，操作简易快捷
- 型号齐全

适用范围

- 会议室、多功能厅
- 各种娱乐场所
- 流动演出

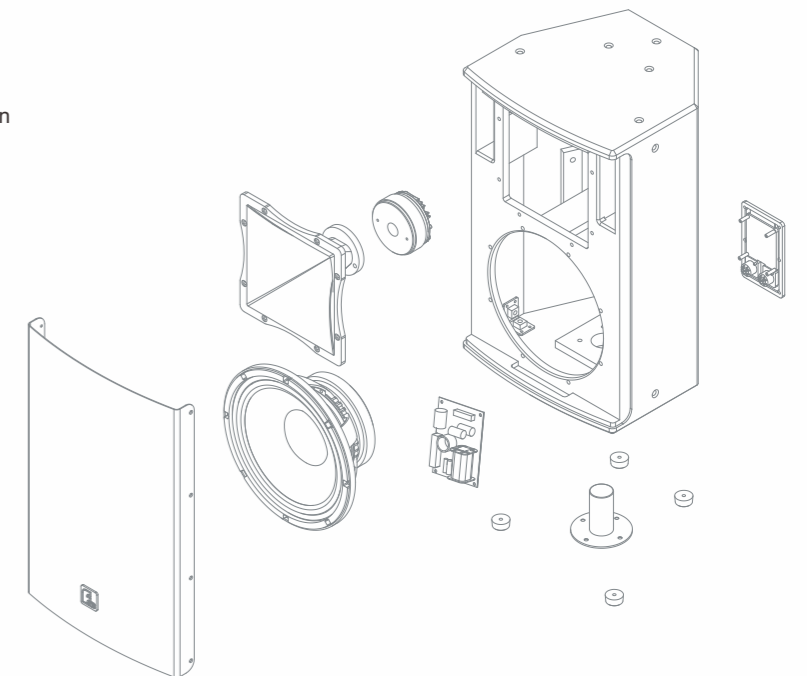

U series Classic Speaker

Two-way Loudspeaker System



MODEL	U106VI	U108VI	U110VI
FREQUENCY RESPONSE(-3dB)	90 Hz-18kHz	60 Hz-18kHz	55 Hz-18kHz
FREQUENCY RESPONSE(-10dB)	85Hz-20kHz	55 Hz-20kHz	50 Hz-20kHz
LF DRIVER	1 × 6.5"/ 2"voice coil	1 × 8"/ 2"voice coil	1 × 10"/ 2.5"voice coil
HF DRIVER	1 × 1"/ 1"voice coil	1 × 1"/ 1"voice coil	1 × 1"/ 1.7"voice coil
RATED POWER	120W RMS,480W peak	150W RMS,600W peak	250W RMS,1000W peak
SENSITIVITY	90dB 1watt/1 metre	93dB 1watt/1 metre	95dB 1watt/1 metre
MAXIMUM SPL	111dB continuous,117 dB peak	115dB continuous,121 dB peak	119dB continuous,125 dB peak
IMPEDANCE	8 ohms	8 ohms	8 ohms
DISPERSION(-6dB)	110° × 50°	90° × 50°	90° × 50°
CROSSOVER FREQUENCIES	2.5kHz passive	2.8kHz passive	2kHz passive
INPUT CONNECTORS	Covered barrier strip terminals	Covered barrier strip terminals	2 × Speakon NL4
PACKAGE SIZE	510 × 285 × 450 mm(carton/pair)	330 × 320 × 540 mm	400 × 390 × 595 mm
NET WEIGHT	6 kg/pc	10 kg/pc	15 kg/pc
GROSS WEIGHT	15 kg/pair	12 kg/pc	18 kg/pc

U series Classic Speaker

Two-way Loudspeaker System



MODEL	U112VI	U112DA	U112HVI
FREQUENCY RESPONSE(-3dB)	50Hz-18kHz	50Hz-18kHz	50 Hz-18kHz
FREQUENCY RESPONSE(-10dB)	45 Hz-20kHz	45 Hz-20kHz	45 Hz-20kHz
LF DRIVER	1 × 12"/ 3"voice coil	1 × 12"/ 3"voice coil	1 × 12"/ 3"voice coil
HF DRIVER	1 × 1"/ 1.7"voice coil	1 × 1"/ 1.7"voice coil	1 × 1.4"/ 3"voice coil
RATED POWER	300W RMS,1200W peak	1350W/8Ω+450W/8Ω	450W RMS,1800W peak
SENSITIVITY	97dB 1watt/1meter	--	97dB 1watt/1 metre
MAXIMUM SPL	122dB continuous,128dB peak	122dB continuous,128dB peak	124dB continuous,130 dB peak
IMPEDANCE	8 ohms	--	8 ohms
DISPERSION(-6dB)	90° × 40°	90° × 40°	90° × 40°
CROSSOVER FREQUENCIES	2kHz passive	--	1.5kHz passive
INPUT CONNECTORS	2 × Speakon NL4	Balanced Differential line	2 × Speakon NL4
PACKAGE SIZE	490 × 470 × 730 mm	490 × 470 × 730 mm	530 × 495 × 710 mm
NET WEIGHT	21 kg/pc	23 kg/pc	25 kg/pc
GROSS WEIGHT	25 kg/pc	27 kg/pc	29 kg/pc



pro audio

U series Classic Speaker

Two-way Loudspeaker System



MODEL	U115VI	U115DA	U115HVI	U215VI	U215AVI
FREQUENCY RESPONSE(-3dB)	45Hz-18kHz	45Hz-18kHz	45 Hz-18kHz	40 Hz-18kHz	40 Hz-18kHz
FREQUENCY RESPONSE(-10dB)	40 Hz-20kHz	40 Hz-20kHz	40 Hz-20kHz	35 Hz-20kHz	35 Hz-20kHz
LF DRIVER	1 × 15"/ 3"voice coil	1 × 15"/ 3"voice coil	1 × 15"/ 4"voice coil	2 × 15"/ 4"voice coil	2 × 15"/ 3"voice coil
HF DRIVER	1 × 1.4"/ 3"voice coil	1 × 1"/ 1.7"voice coil	1 × 1.4"/ 3"voice coil	1 × 2"/ 3"voice coil	1 × 2"/ 3"voice coil
RATED POWER	400W RMS,1600W peak	1350W/8Ω+450W/8Ω	600W RMS,2400W peak	1200W RMS,4800W peak	300W/8Ω+1200W/4Ω
SENSITIVITY	98dB 1watt/1meter	--	98dB 1watt/1 metre	101dB 1watt/1meter	--
MAXIMUM SPL	124dB continuous	124dB continuous	126dB continuous	132dB continuous	130dB continuous
	130dB peak	130dB peak	132 dB peak	138dB peak	136dB peak
IMPEDANCE	8 ohms	--	8 ohms	4 ohms	--
DISPERSION(-6dB)	90° × 40°	90° × 40°	90° × 40°	90° × 50°	90° × 50°
CROSSOVER FREQUENCIES	1.5kHz passive	--	1.5kHz passive	1.5kHz passive	--
INPUT CONNECTORS	2 × Speakon NL4	Balanced Differential line	2 × Speakon NL4	2 × Speakon NL4	Balanced Differential line
PACKAGE SIZE	580 × 560 × 820mm	580 × 560 × 820mm	580 × 560 × 820mm	660 × 605 × 1250mm	660 × 605 × 1250mm
NET WEIGHT	30 kg/pc	29 kg/pc	33 kg/pc	64 kg/pc	55 kg/pc
GROSS WEIGHT	35 kg/pc	34 kg/pc	38 kg/pc	70 kg/pc	61 kg/pc



pro audio

U series Classic Speaker

Subwofer System



MODEL	U115W	U115WA
FREQUENCY RESPONSE(-10dB)	40Hz-300Hz	40Hz-300Hz
LF DRIVER	1 × 15"/4"voice coil	1 × 15"/4"voice coil
RATED POWER	600W RMS	1200W/4Ω
	2400W peak	
SENSITIVITY	99dB 1watt/1meter	--
MAXIMUM SPL	127dB continuous	127dB continuous
	133dB peak	133dB peak
IMPEDANCE	8 ohms	--
INPUT CONNECTORS	2 × Speakon NL4	Balanced Differential line
PACKAGE SIZE	670 × 550 × 605mm	670 × 550 × 605mm
NET WEIGHT	31 kg/pc	33 kg/pc
GROSS WEIGHT	34 kg/pc	36 kg/pc

MODEL	U118W	U118WA
FREQUENCY RESPONSE(-10dB)	35Hz-300Hz	35Hz-300Hz
LF DRIVER	1 × 18"/4"voice coil	1 × 18"/4"voice coil
RATED POWER	600W RMS	1200W/4Ω
	2400W peak	
SENSITIVITY	100dB 1watt/1meter	--
MAXIMUM SPL	128dB continuous	128dB continuous
	134dB peak	134dB peak
IMPEDANCE	8 ohms	--
INPUT CONNECTORS	2 × Speakon NL4	Balanced Differential line
PACKAGE SIZE	880 × 660 × 655mm	880 × 660 × 655mm
NET WEIGHT	40 kg/pc	42 kg/pc
GROSS WEIGHT	48 kg/pc	50 kg/pc

MODEL	U218W	U218WA
FREQUENCY RESPONSE(-10dB)	35Hz-300Hz	35Hz-300Hz
LF DRIVER	2 × 18"/4"voice coil	2 × 18"/4"voice coil
RATED POWER	1200W RMS	1200W/4Ω
	4800W peak	+1200W/4Ω
SENSITIVITY	103dB 1watt/1meter	--
MAXIMUM SPL	134dB continuous	134dB continuous
	140dB peak	140dB peak
IMPEDANCE	4 ohms	--
INPUT CONNECTORS	2 × Speakon NL4	Balanced Differential line
PACKAGE SIZE	1272 × 872 × 658mm	1272 × 872 × 658mm
NET WEIGHT	82 kg/pc	84 kg/pc
GROSS WEIGHT	90 kg/pc	92 kg/pc

U106VI

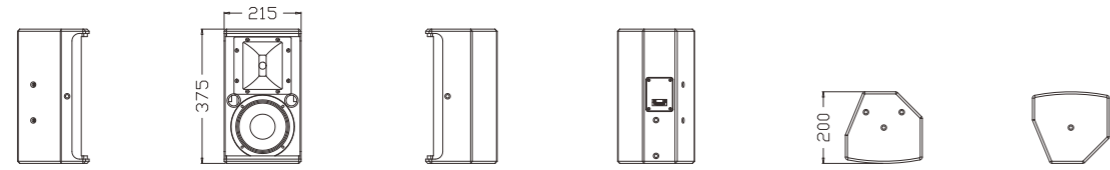

U108VI

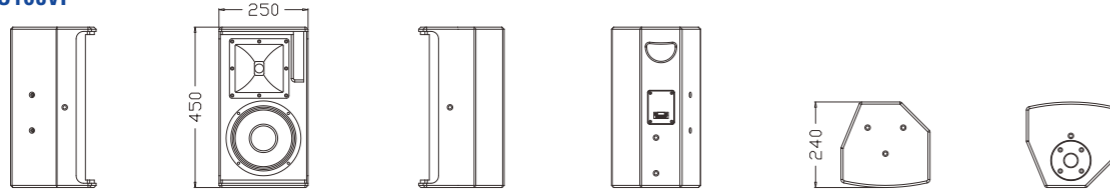

U110VI

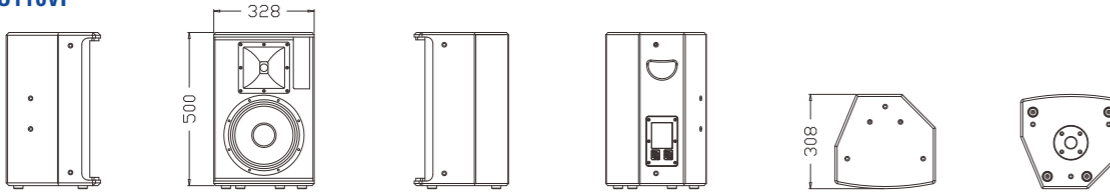

U112VI

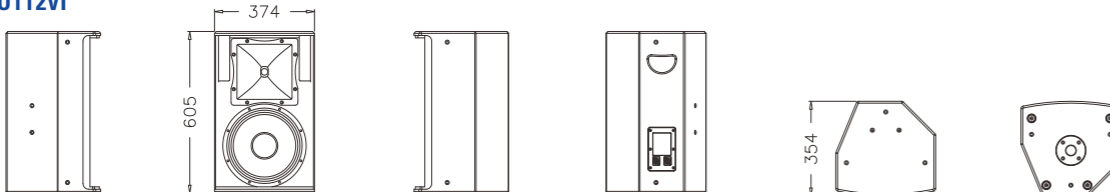

U112DA

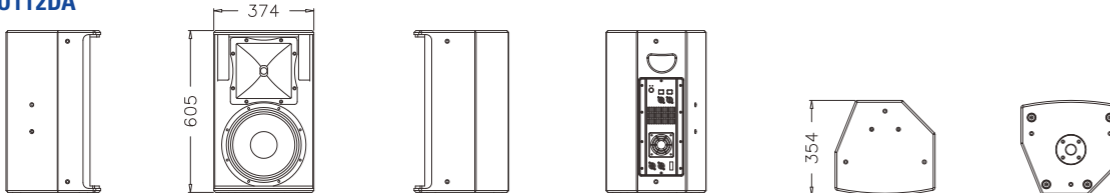

U112HVI

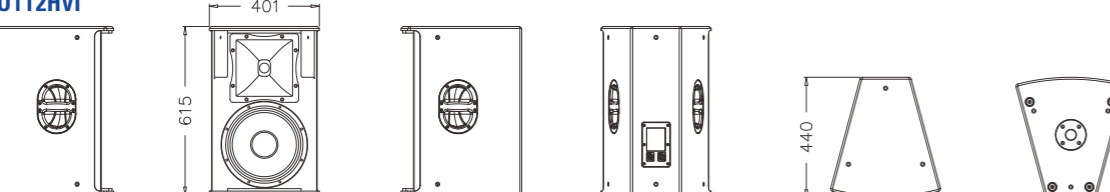

U115HVI

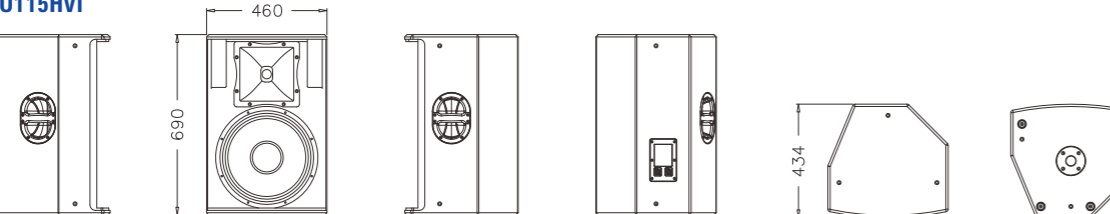

U115VI

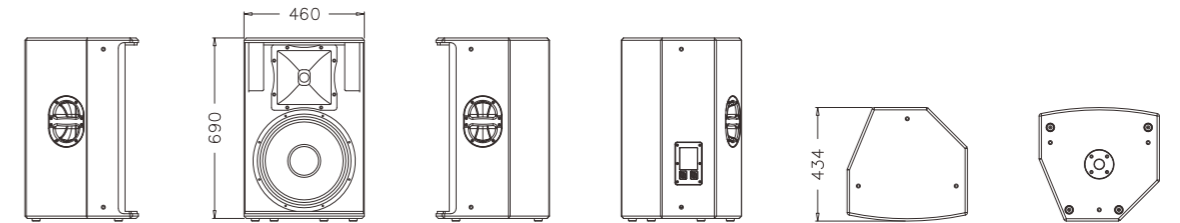

U115DA

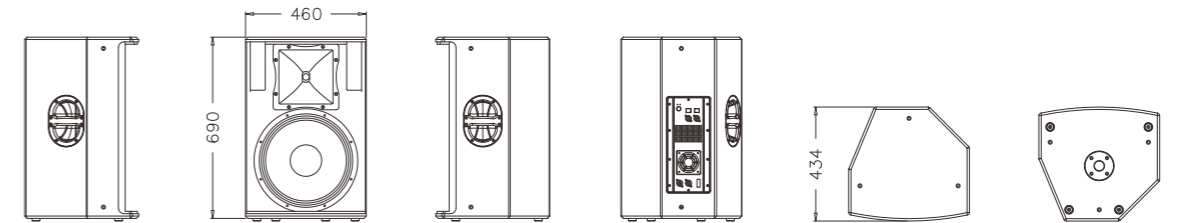

U215VI/U215AVI

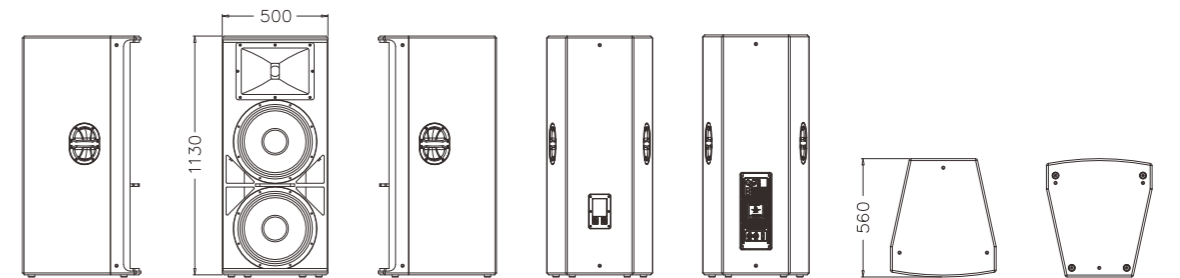

U115W/U115WA

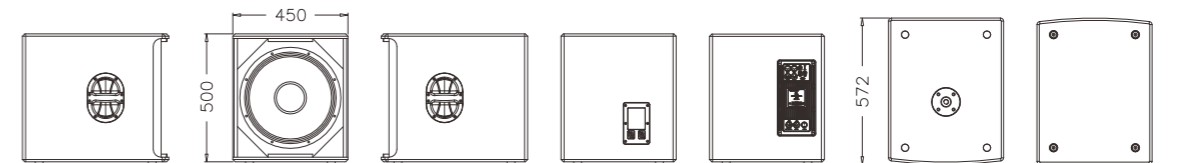

U118W/U118WA

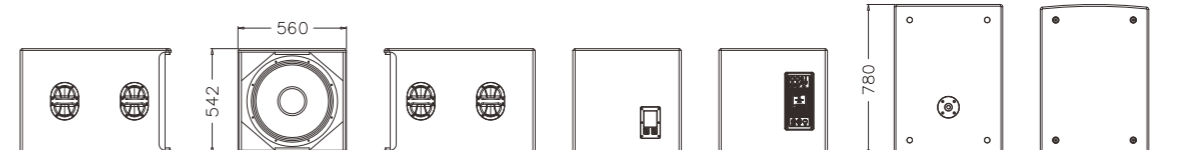

U218W/U218WA





U112DA



U115DA



U215AVI



U115WA



U118WA



U218WA